

B向 连接法兰尺寸

A向 底座安装尺寸

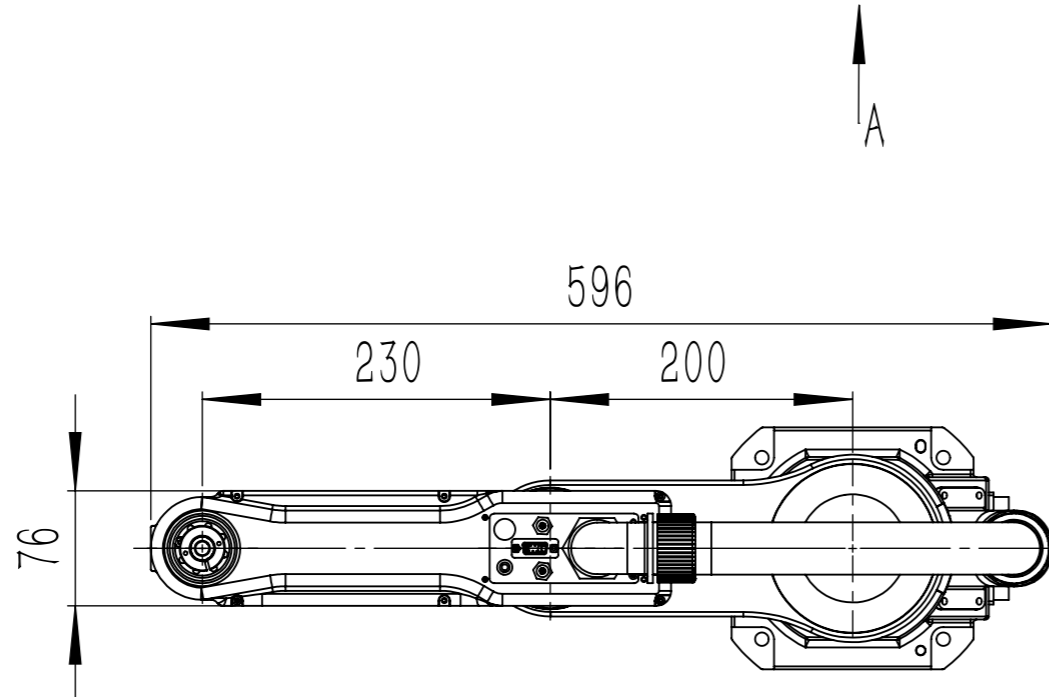
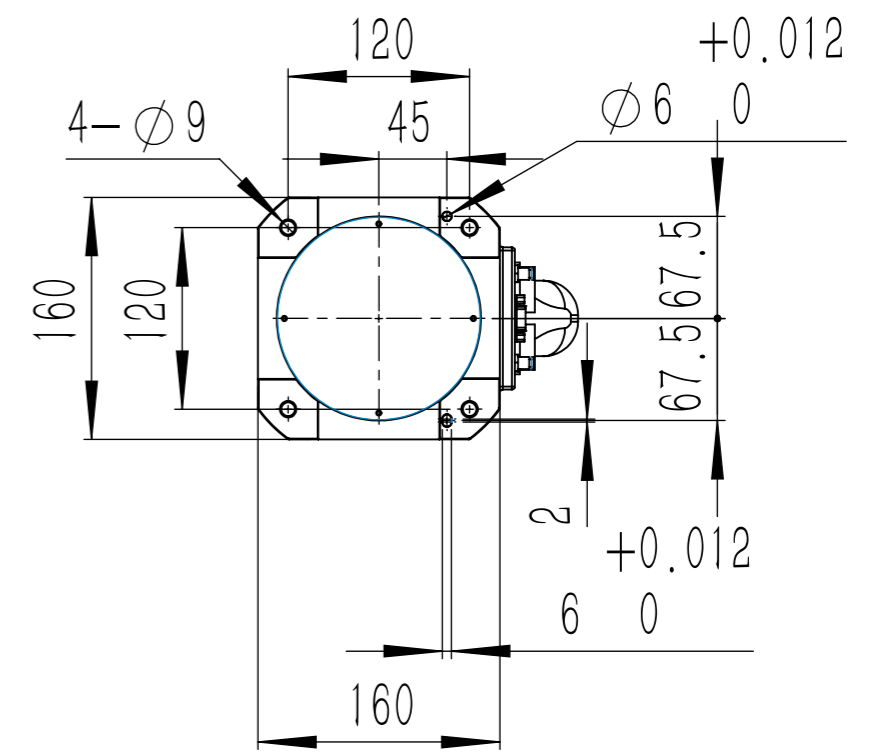

C4-0404外形尺寸图

长陕望远

零件代号
借(通)用件登记
描图
描校
旧底图总号
底图总号
签字
日期